

## VERTICAL SERIES BOOSTER PUMPS

### Stainless Steel Vertical Multistage Centrifugal Pump



#### **The Webtrol V Series**

Vertical multistage pumps offer technically advanced designs to meet market demands including hot water applications.

Every Webtrol V Series pump is hand assembled and checked during each step of the assembly process up to the final test where each pump is checked for flow, pressure, power consumption, leaks, vibration and noise.

#### **Features / Benefits**

Space saving vertical design.

Floating outer casing allows for thermal expansion in hot water application and is flexible preventing deformation due to pressure fluctuations.

Unique bulge forming process produces rugged construction with increased wall thickness and assures component integrity.

All wetted parts are constructed of high quality stainless steel. Available in 304 and 316 stainless steel.\*

Robust construction extends to critical internal components such as the impellers. The back shrouds are as much as three times thicker than the front shrouds while front shrouds are 20% to 60% thicker than comparable designs.

#### **Performance**

Capacities to 375 GPM

Pressures to 360 PSI

Temperature to 248° F

#### **Typical Services**

- Water Supply
- Reverse Osmosis
- Water Boosting
- Washing Systems
- Fire Fighting
- Water Treatment
- Filtration
- Plants
- Boiler Feed
- Hot & Cold Water
- Circulation
- Irrigation
- Sprinkler Systems
- Heat Exchangers

\* V140, V200 & V300 Series pumps have cast iron inlet and outlet connections.

## VERTICAL FAMILY SERIES

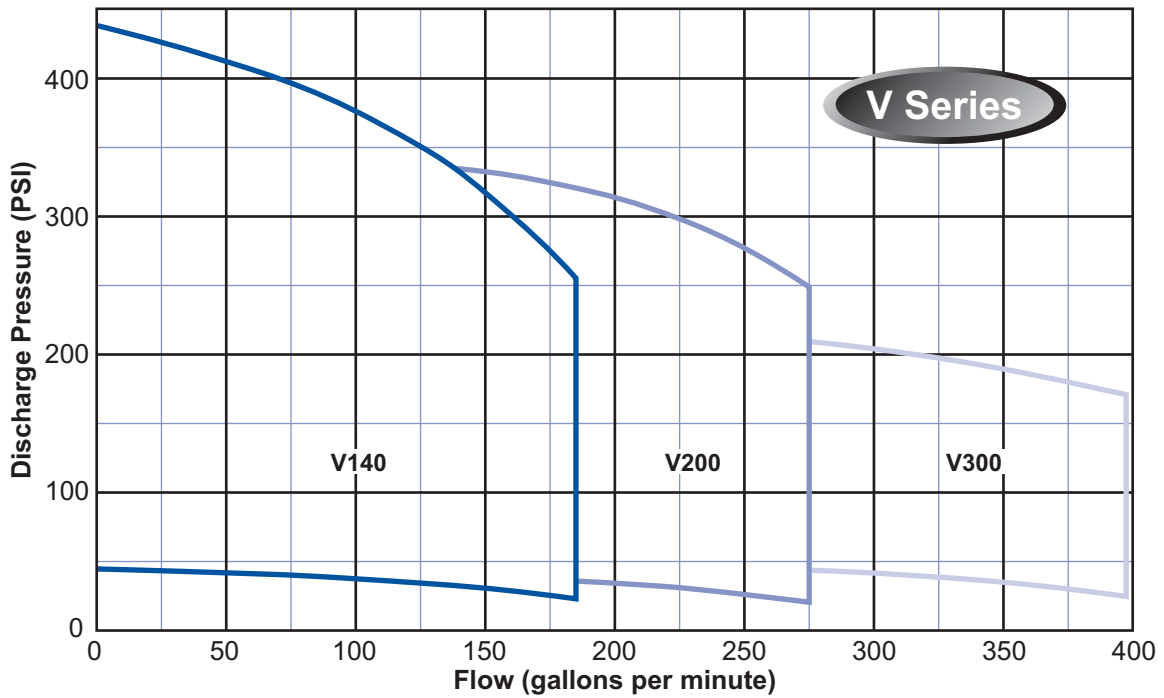
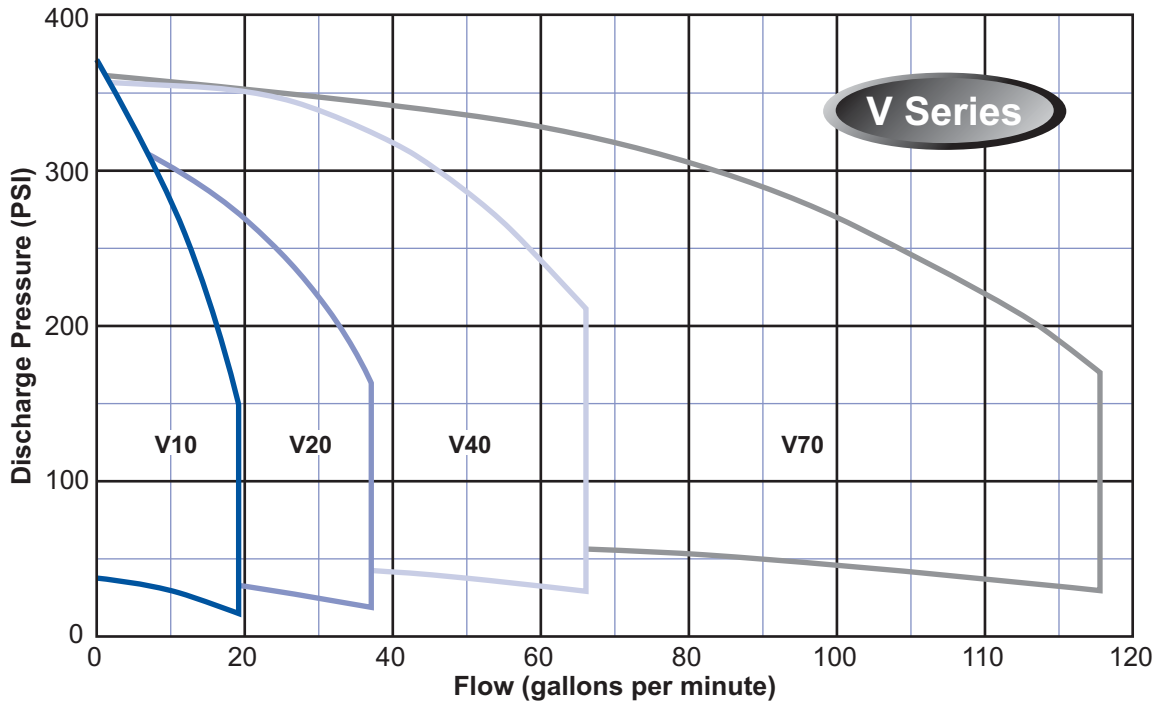

## VERTICAL SERIES GROUP CURVES

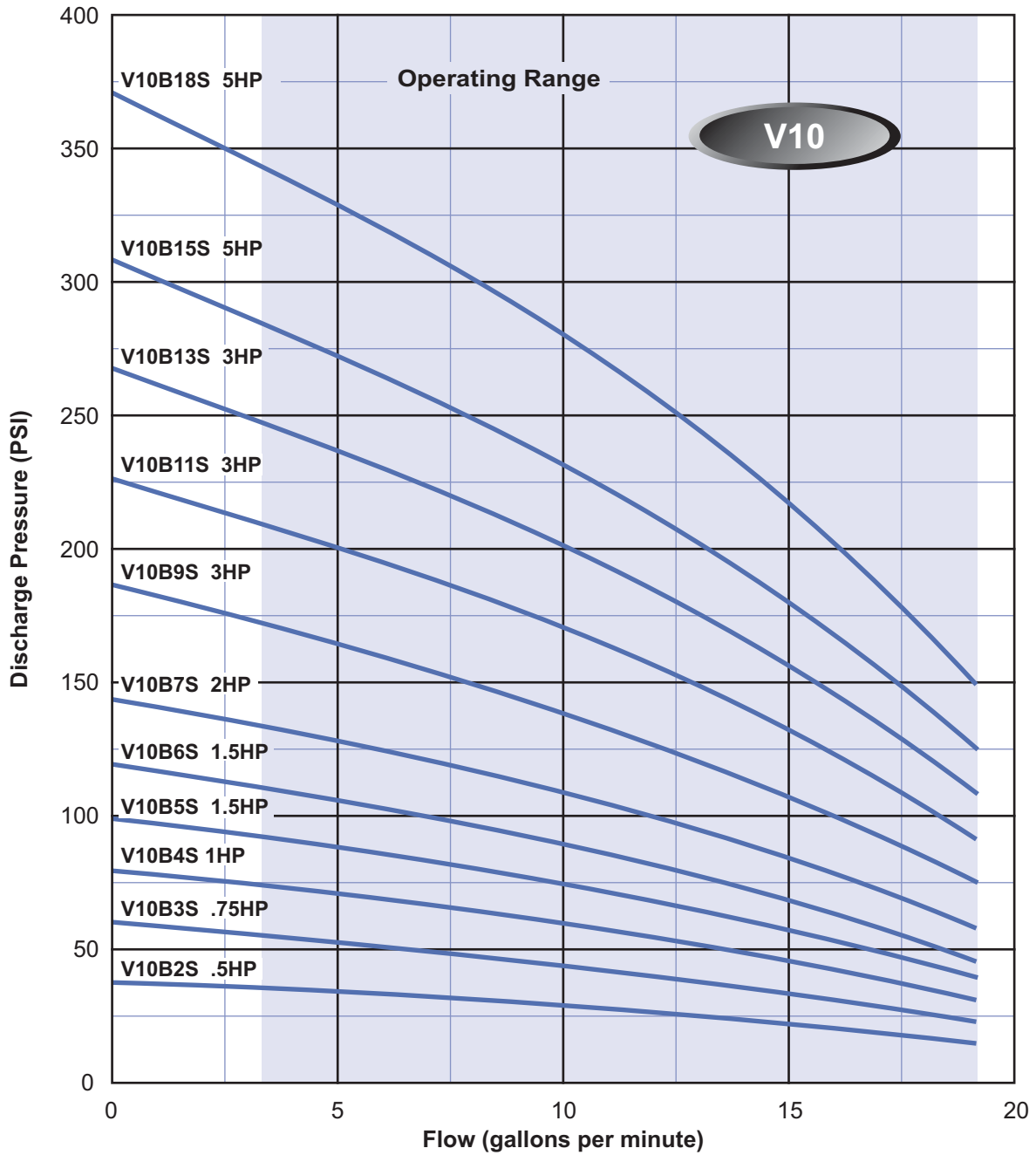

## VERTICAL SERIES BOOSTER - 10 Series

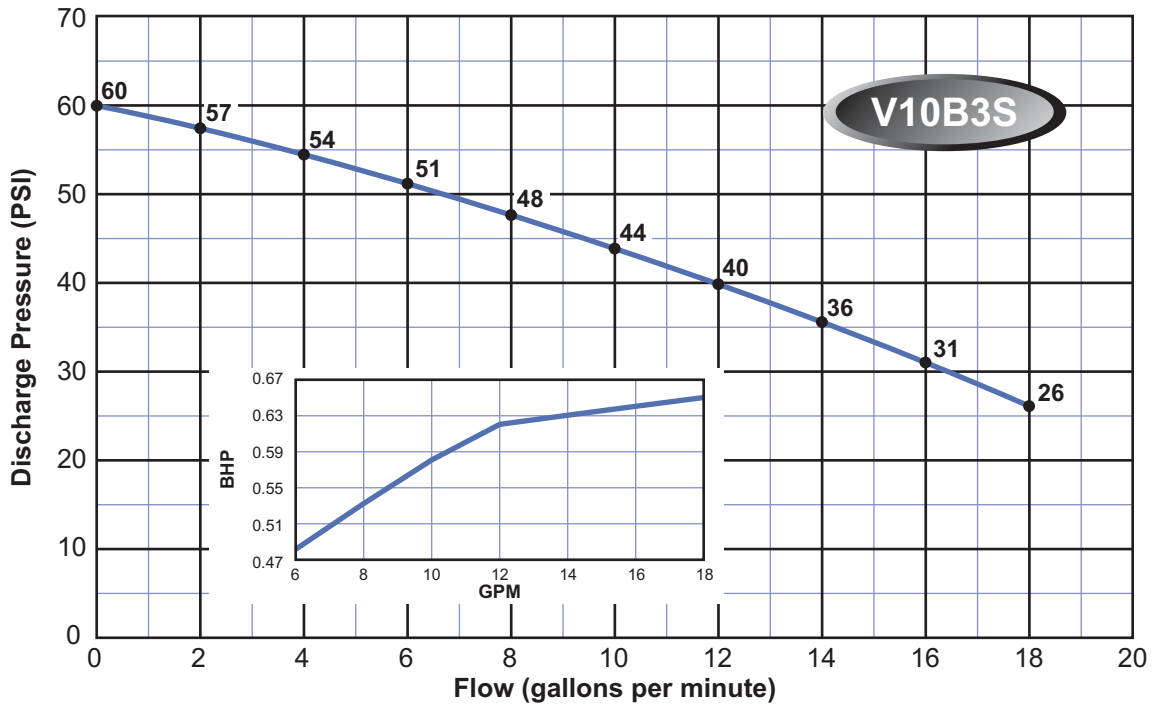
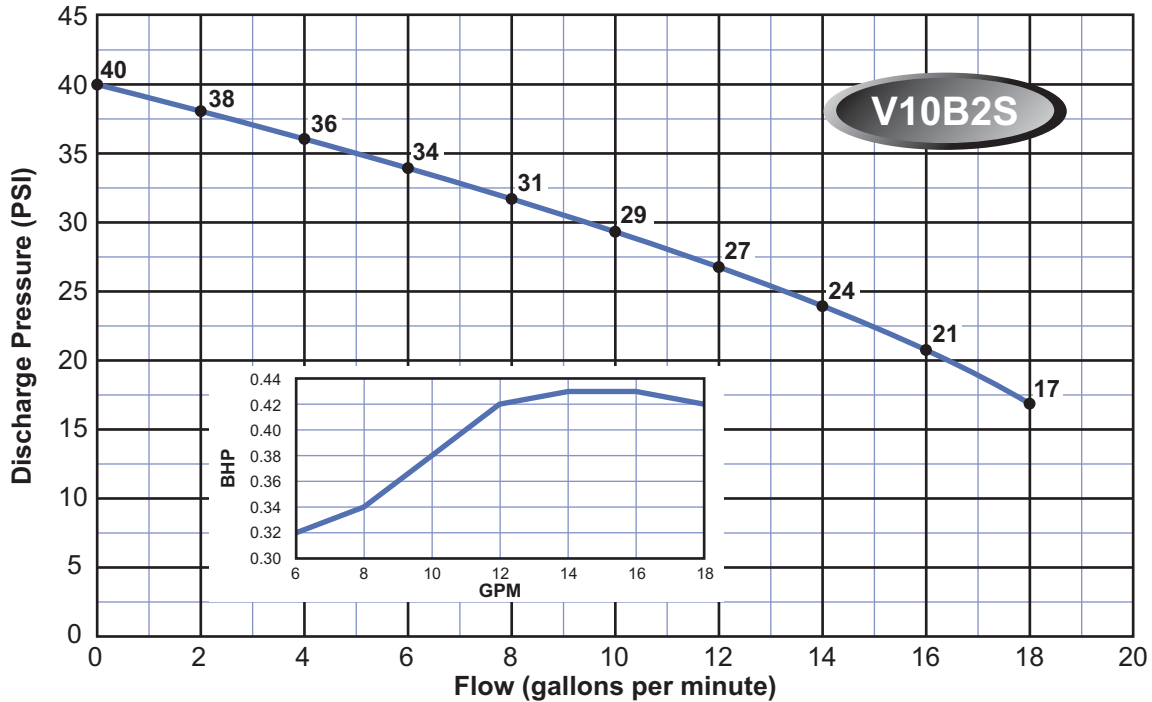

**Note:**

Curves are based on 60 Hz 3450 rpm motors. 50 Hz 2875 rpm curves are available. These curves are for general guidance only, individual pump curves are available upon request. A certified curve may be requested for an additional cost. Webtrol will build pumps to fit your specific needs, contact factory for pricing.

## VERTICAL SERIES BOOSTER - 10 Series

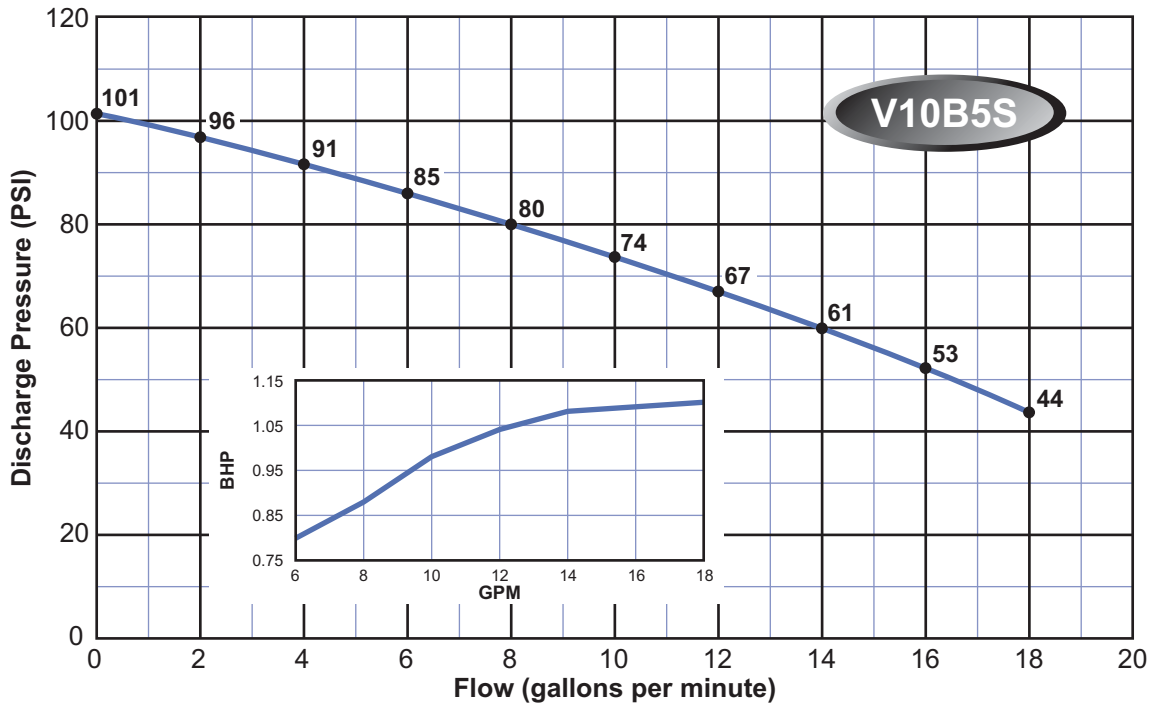
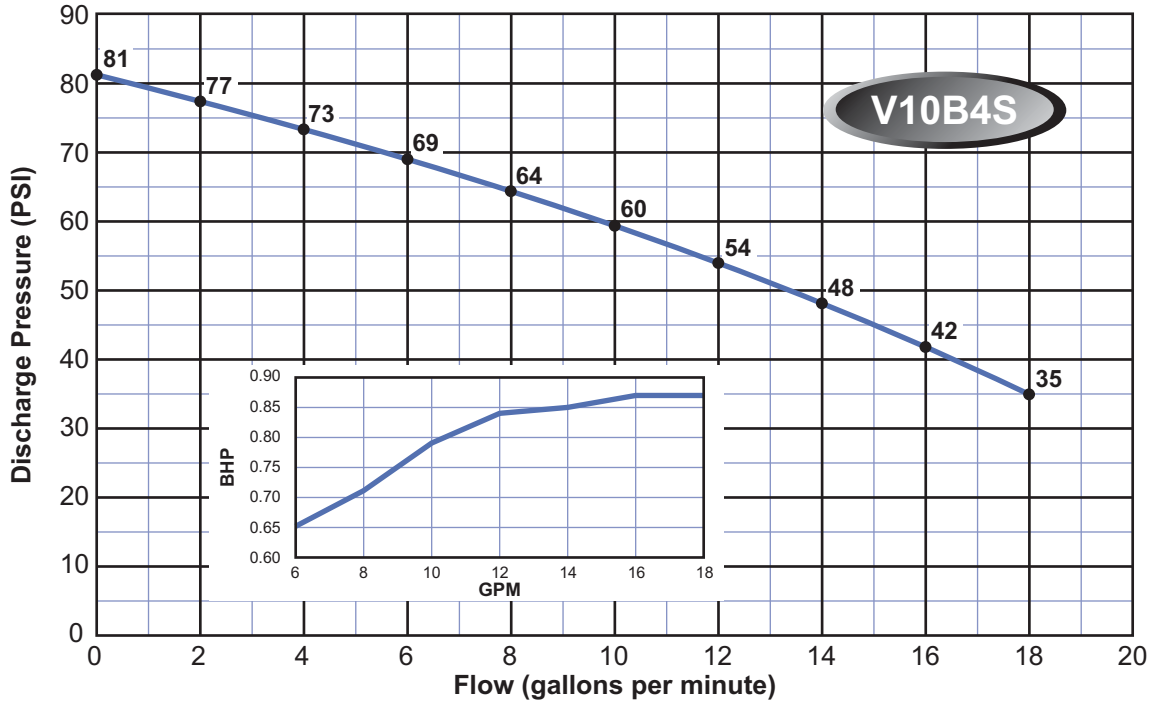

**Note:**

Curves are based on 60 Hz 3450 rpm motors. 50 Hz 2875 rpm curves are available. These curves are for general guidance only, individual pump curves are available upon request. A certified curve may be requested for an additional cost. Webtrol will build pumps to fit your specific needs, contact factory for pricing.

## VERTICAL SERIES BOOSTER - 10 Series

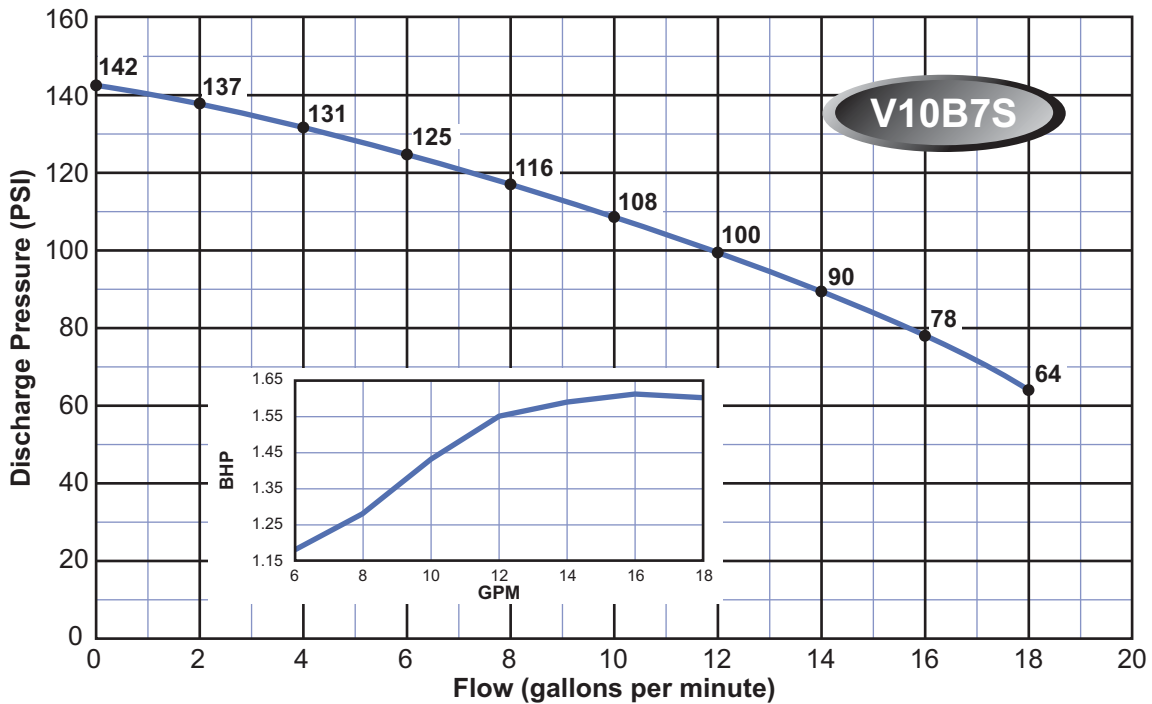
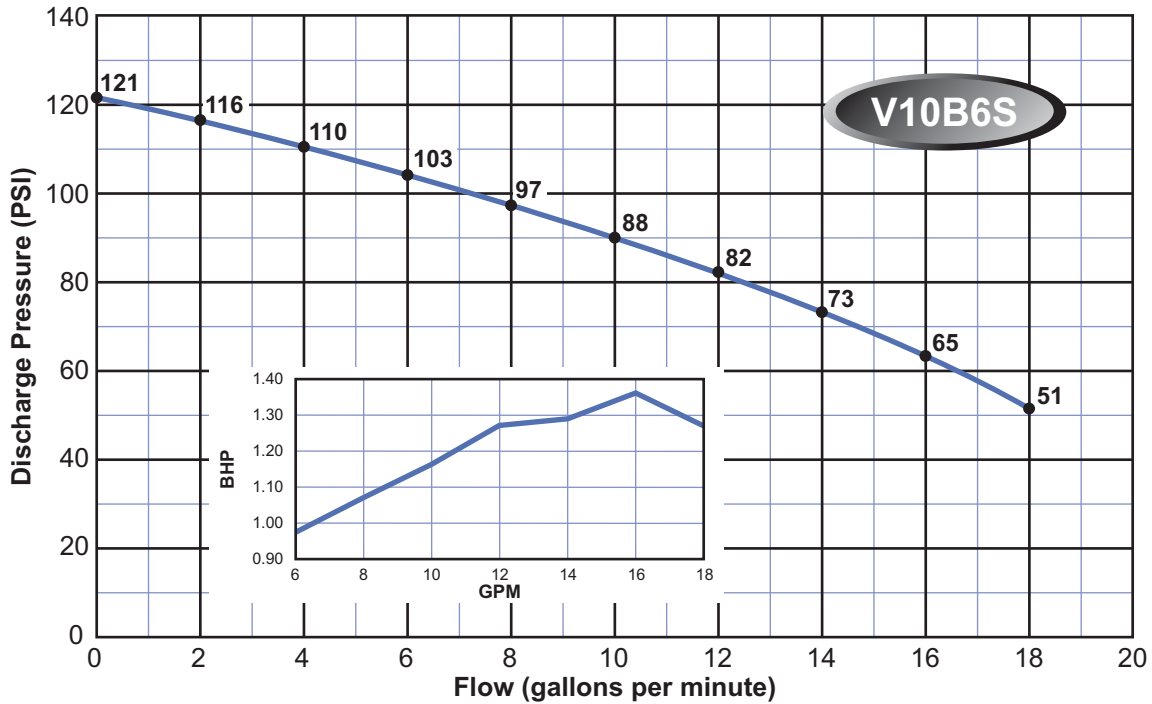

**Note:**

Curves are based on 60 Hz 3450 rpm motors. 50 Hz 2875 rpm curves are available. These curves are for general guidance only, individual pump curves are available upon request. A certified curve may be requested for an additional cost. Webtrol will build pumps to fit your specific needs, contact factory for pricing.

## VERTICAL SERIES BOOSTER - 10 Series

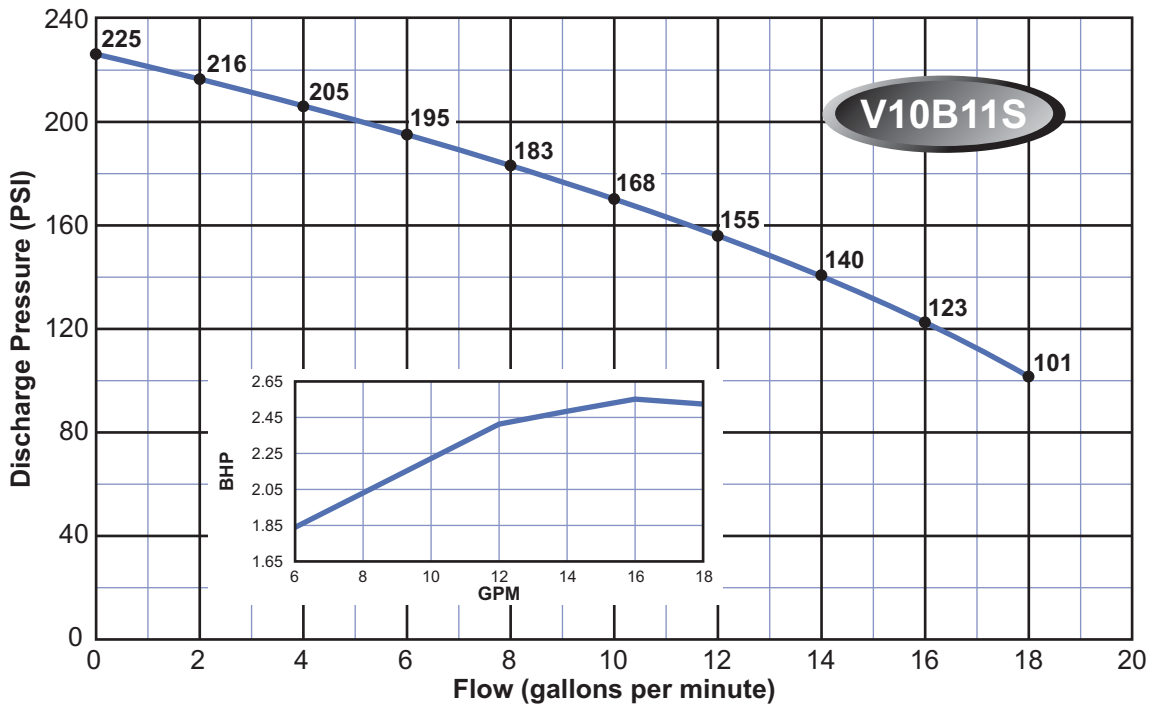
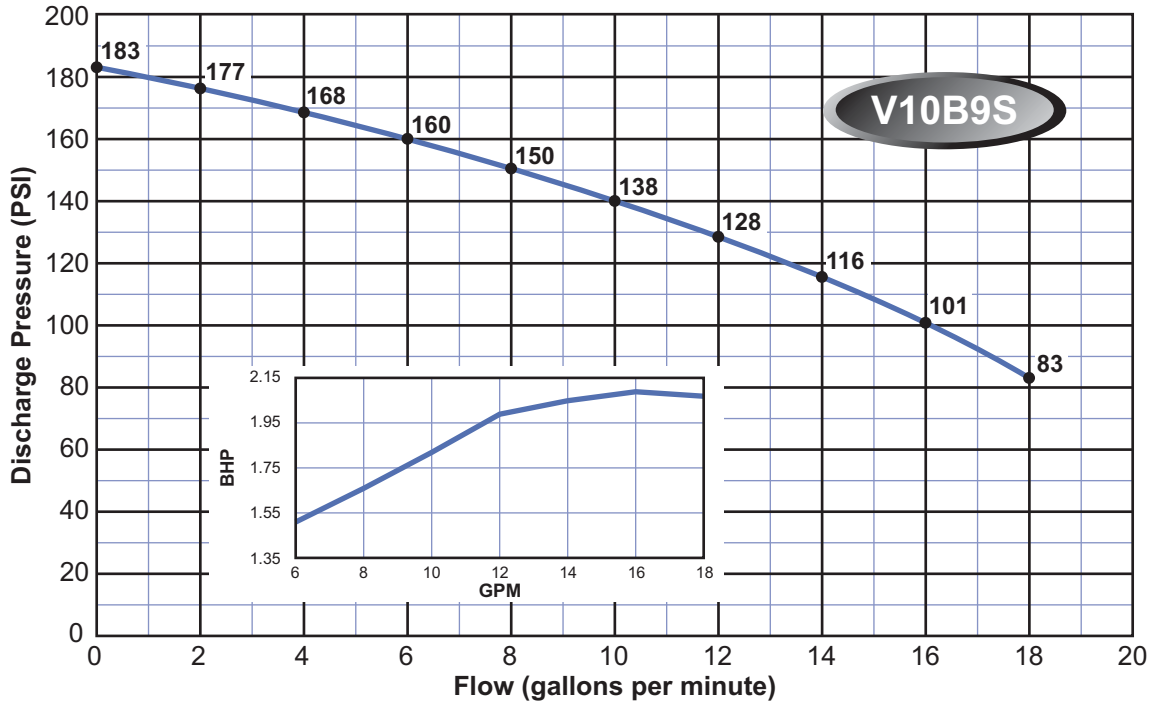

**Note:**

Curves are based on 60 Hz 3450 rpm motors. 50 Hz 2875 rpm curves are available. These curves are for general guidance only, individual pump curves are available upon request. A certified curve may be requested for an additional cost. Webtrol will build pumps to fit your specific needs, contact factory for pricing.

## VERTICAL SERIES BOOSTER - 10 Series

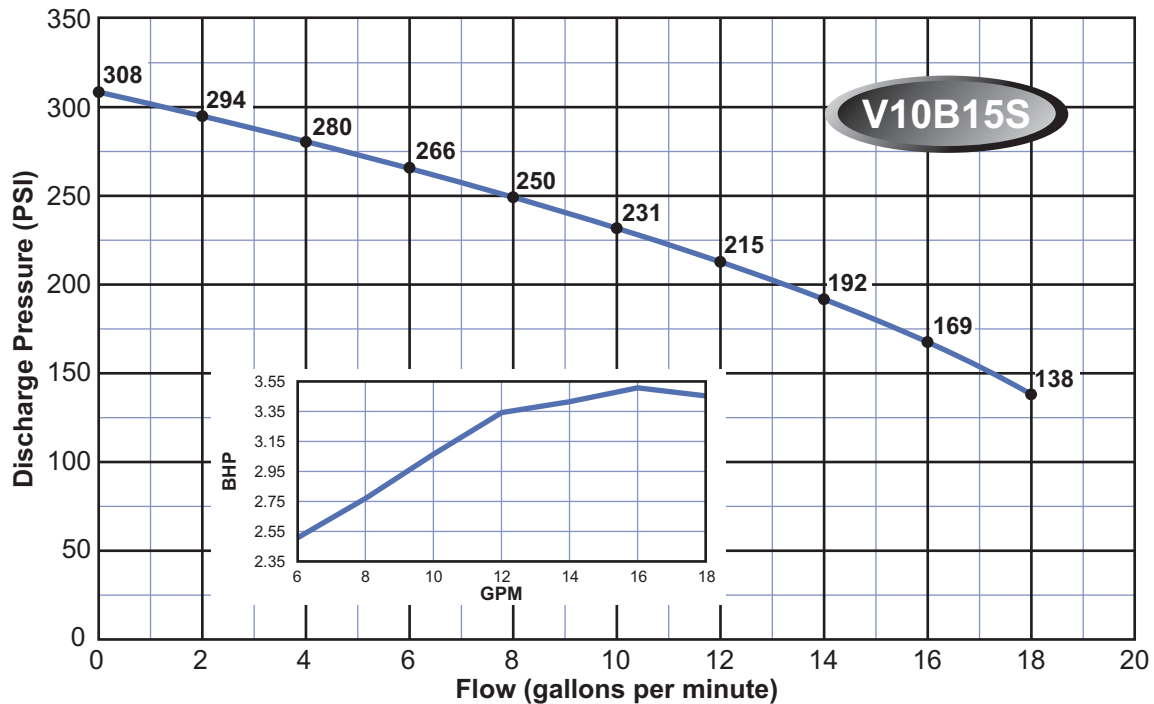
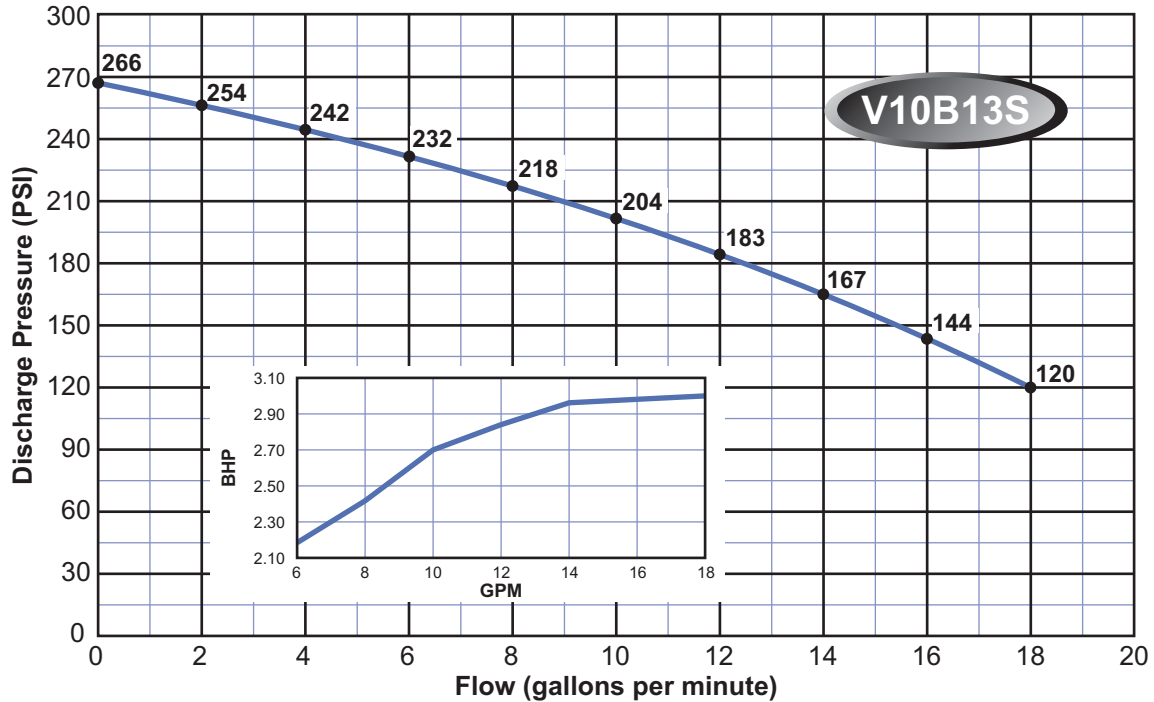

**Note:**

Curves are based on 60 Hz 3450 rpm motors. 50 Hz 2875 rpm curves are available. These curves are for general guidance only, individual pump curves are available upon request. A certified curve may be requested for an additional cost. Webtrol will build pumps to fit your specific needs, contact factory for pricing.



## VERTICAL SERIES BOOSTER - 10 Series

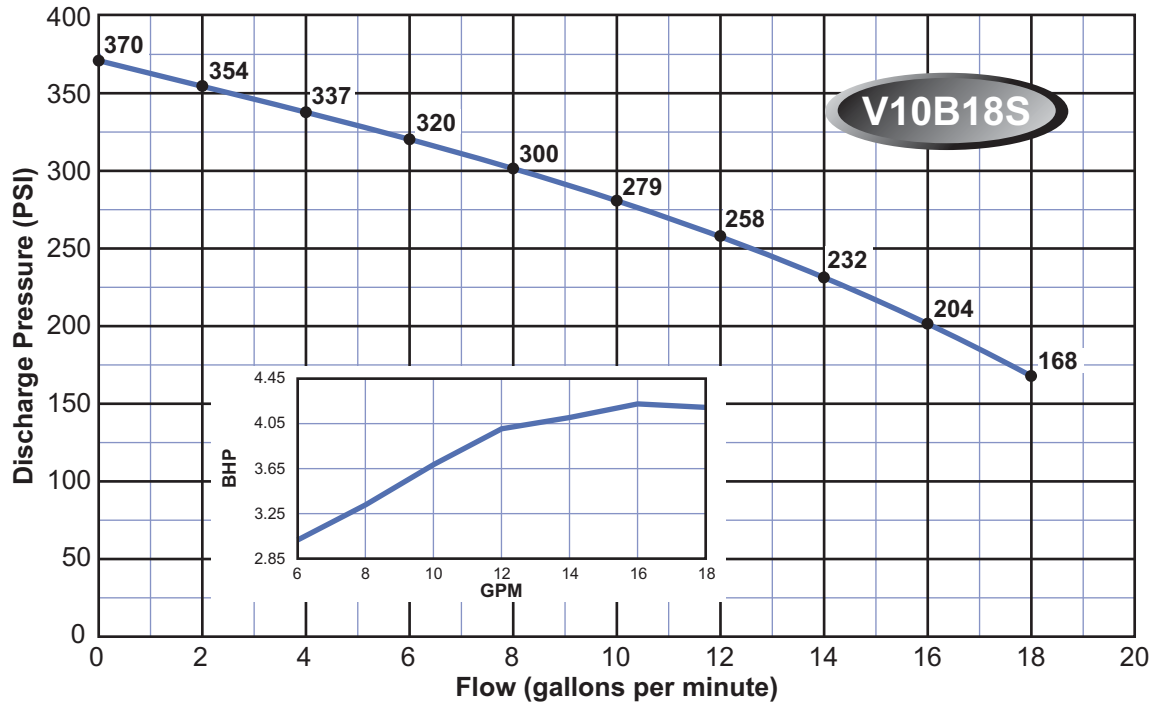

**Note:**

Curves are based on 60 Hz 3450 rpm motors. 50 Hz 2875 rpm curves are available. These curves are for general guidance only, individual pump curves are available upon request. A certified curve may be requested for an additional cost. Webtrol will build pumps to fit your specific needs, contact factory for pricing.

## VERTICAL SERIES BOOSTER DIMENSIONS

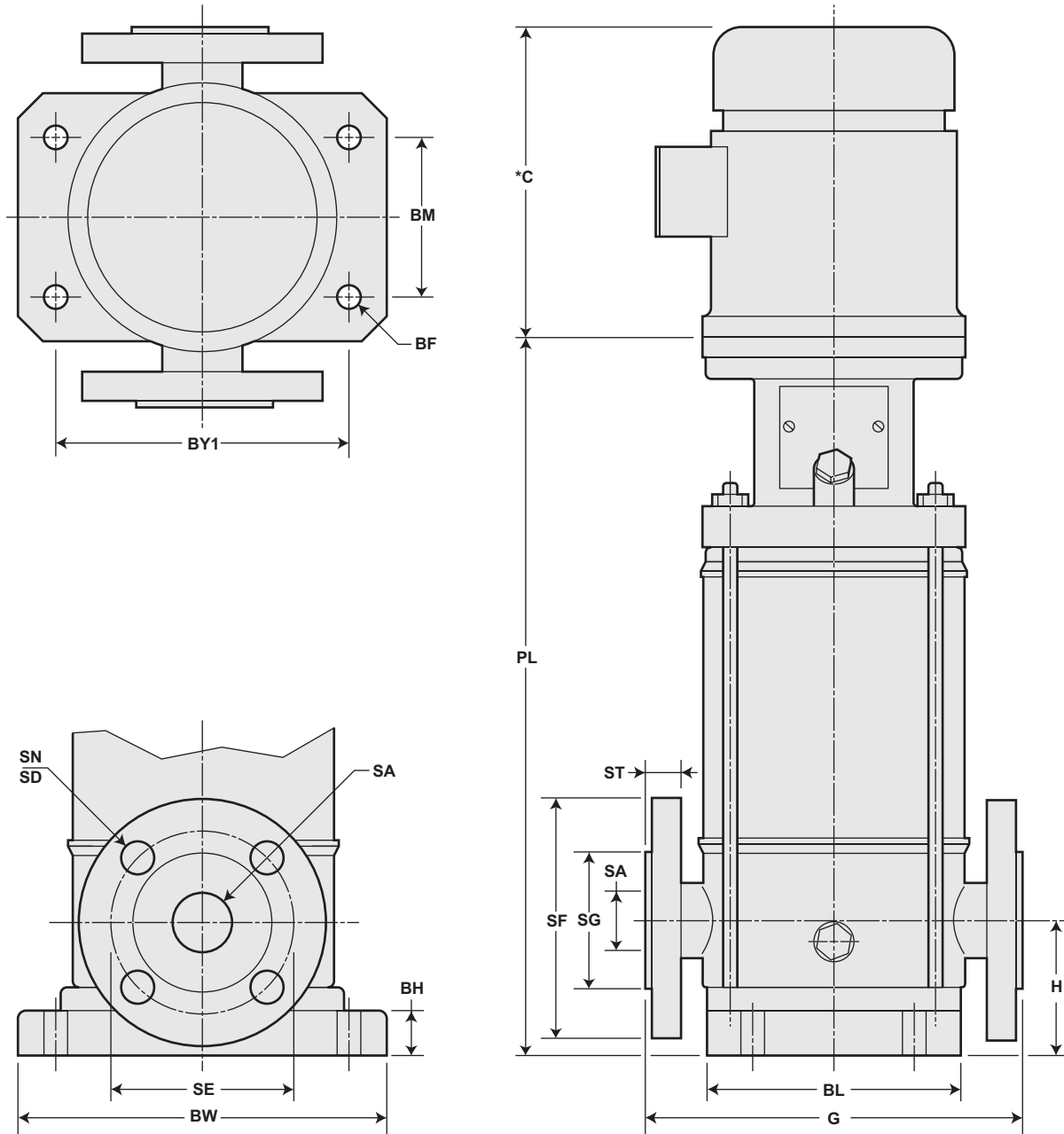

Note: \*C = Motor Dimension - refer to motor manufacturer's catalog



## VERTICAL SERIES BOOSTER DIMENSIONS V10 - V70

MODEL NO.	HP	FRAME	PL	H	G	ST	SA	SG	SF	SD	SN	SE	BM	BY1	BL	BW	BF	BH
V10B2S	0.50	56C	11 5/16															
V10B3S	0.75	56C	12 9/64															
V10B4S	1	56C	12 31/32															
V10B5S	1.5	143TC	13 55/64															
V10B6S	1.5	143TC	14 11/16															
V10B7S	2	145TC	15 17/32	2 61/64	9 27/32	23/32	1 3/8	2 63/64	5 33/64	3/4	4	3 7/8	3 15/16	7 3/32	5 55/64	8 17/64	15/32	25/32
V10B9S	3	145TC	17 3/16															
V10B11S	3	145TC	18 27/32															
V10B13S	3	145TC	20 57/64															
V10B15S	5	184TC	22 57/64															
V10B18S	5	184TC	25 3/8															
V20B2S	0.75	56C	11 7/8															
V20B3S	1.5	143TC	13 1/32															
V20B4S	2	145TC	14 9/64															
V20B5S	2	145TC	15 15/64															
V20B6S	3	145TC	16 23/64															
V20B7S	3	145TC	17 55/64															
V20B8S	3	145TC	18 61/64	2 61/64	9 27/32	23/32	1 3/8	2 63/64	5 33/64	3/4	4	3 7/8	3 15/16	7 3/32	5 55/64	8 17/64	15/32	25/32
V20B10S	5	184TC	21 33/64															
V20B11S	5	184TC	22 5/8															
V20B12S	5	184TC	23 23/32															
V20B14S	7.5	184TC	25 59/64															
V20B16S	7.5	184TC	28 5/32															
V40B2S	1.5	143TC	14 1/64															
V40B3S	3	145TC	15 13/64															
V40B4S	3	145TC	16 49/64															
V40B5S	5	184TC	18 13/16															
V40B6S	5	184TC	20															
V40B8S	7.5	184TC	22 3/8	3 35/64	11 51/64	23/32	1 31/32	4 1/64	6 1/2	3/4	8	5	5 1/8	8 15/32	7 31/64	9 27/32	15/32	25/32
V40B10S	7.5	213TC	24 3/4															
V40B12S	10	215TC	27 7/64															
V40B14S	15	215TC	29 41/64															
V40B16S	15	215TC	32															
V70B2S	5	184TC	15 9/16															
V70B3S	7.5	184TC	17 41/64															
V70B4S	7.5	184TC	19 7/32															
V70B5S	10	215TC	20 25/32															
V70B6S	15	215TC	22 9/16	3 35/64	11 51/64	23/32	1 31/32	4 1/64	6 1/2	3/4	8	5	5 1/8	8 15/32	7 31/64	9 27/32	15/32	25/32
V70B7S	15	215TC	24 9/64															
V70B8S	15	215TC	25 45/64															
V70B10S	20	256TC	28 55/64															
V70B11S	25	284TSC	30 37/64															

Note: All measurements are in inches.

### Flange Dimensions & Accessories

Model No.	Suction/Discharge	Flange	Flange Part No.	Bolt Kit Part No.	Gasket Part No.
V10 & V20	ANSI 300 Lb	1 1/4" - 4 Bolt	29VT125-S	29VT125-SK	28V125-M
V40 & V70	ANSI 300 Lb	2" - 8 Bolt	29VT200-S	29VT200-SK	28V200-M

Note: Accessories purchased separately.